

Tefal®

SIMPLY INVENTS

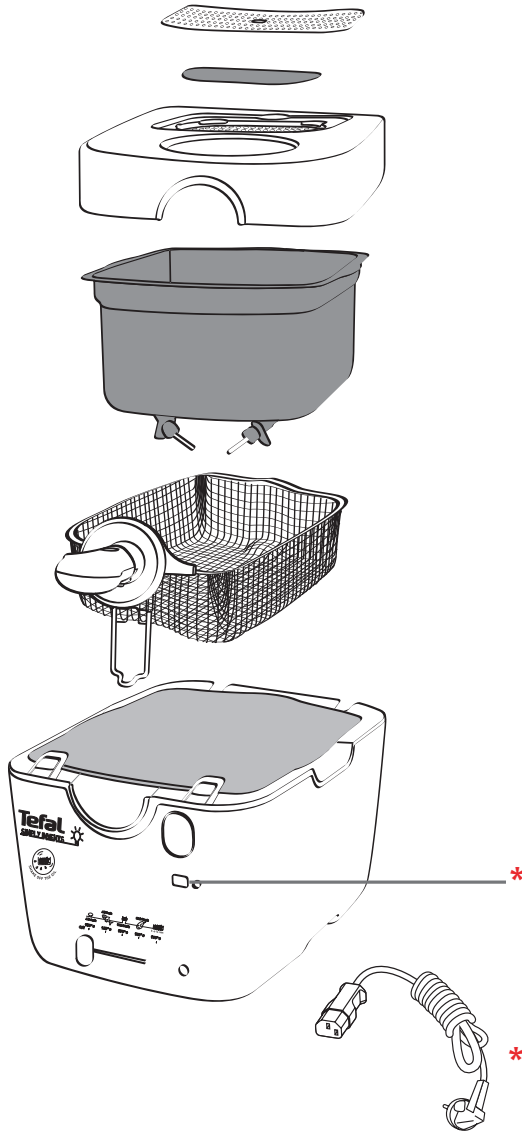



* selon modèle, je nach Modell, niet op alle modellen aanwezig, a seconda del modello, según modelo, conforme o modelo, bazı modellerde, afhængig af model, beroende på modell, kun på noen modeller, mallista riippuen, ανάλογα με το μοντέλο, в зависимости от модели, w zależności od modelu, podle modelu, podl'a modelu, modelltől függően, според модела, حسب الموديل

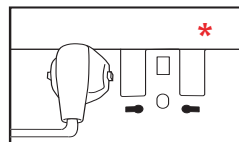

1

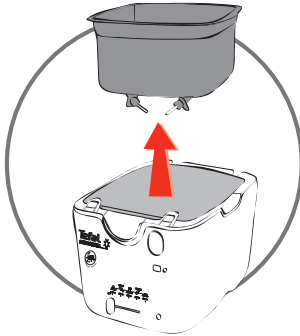
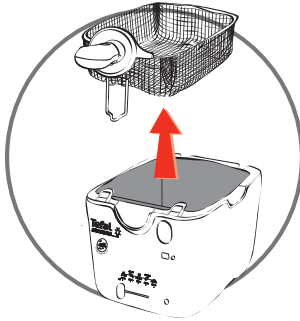
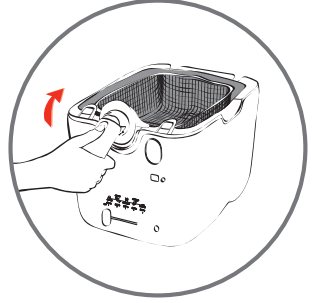
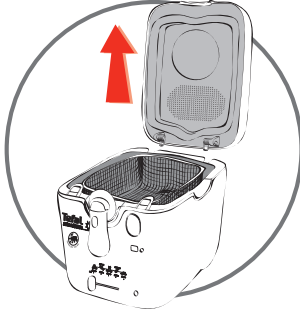
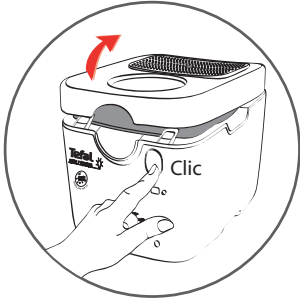
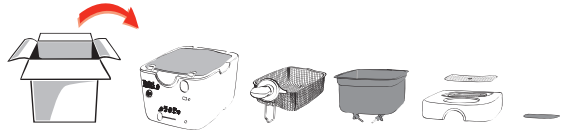

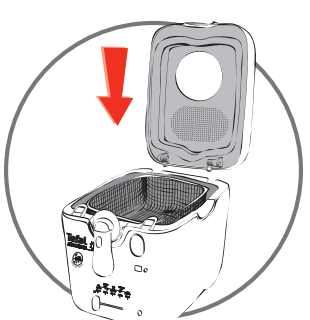
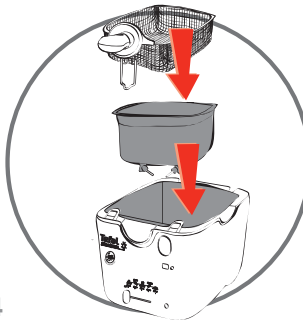
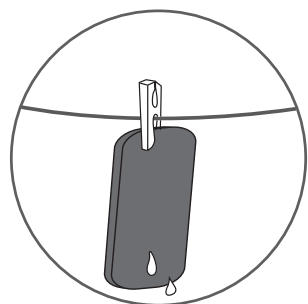
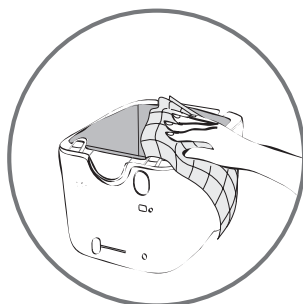
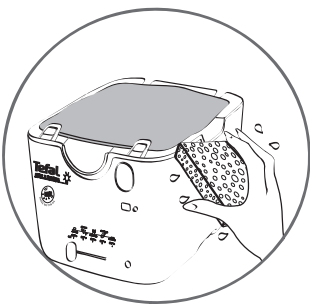
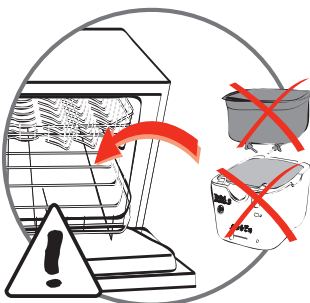
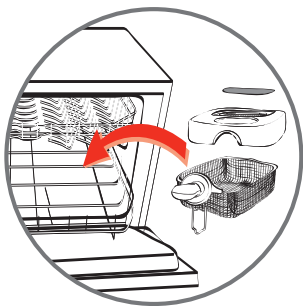
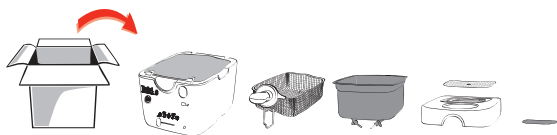

2



Min 2 L
↓
Max 2,2 L

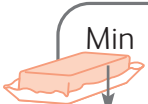
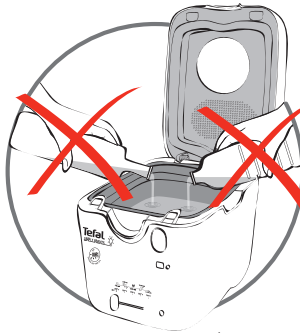
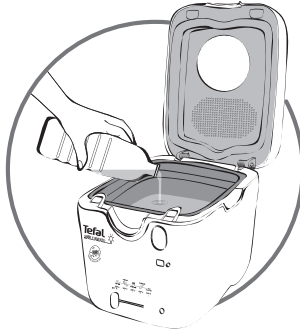

Min 1750 g
↓
Max 2000 g

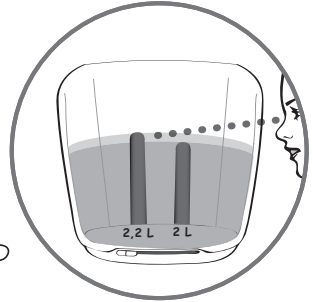
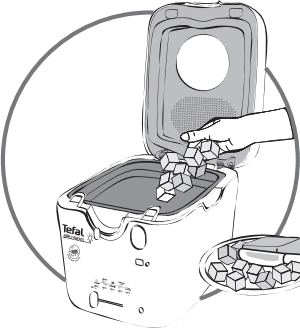



Max.	1,4 kg
	700 g

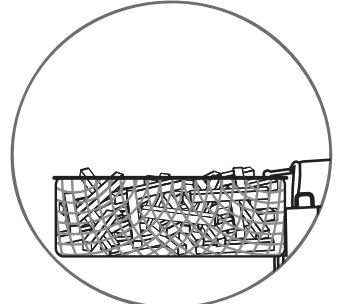

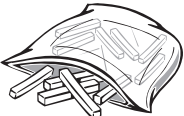



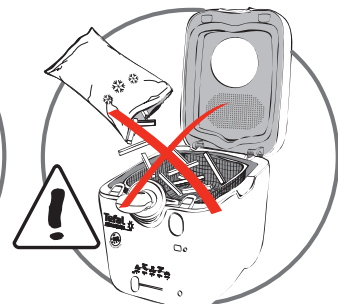
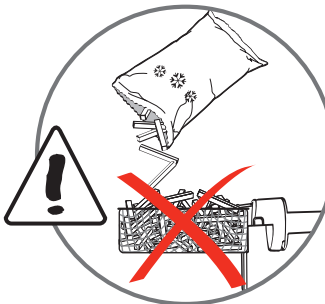
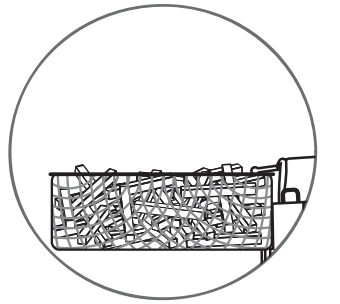

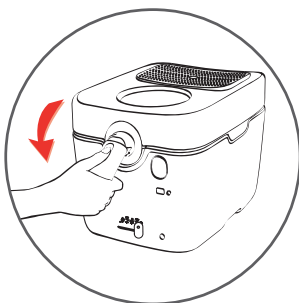
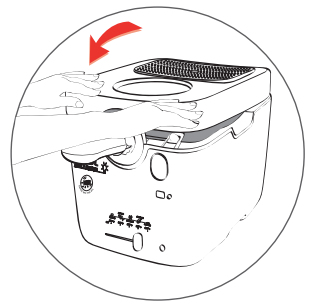
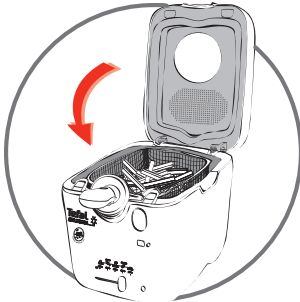
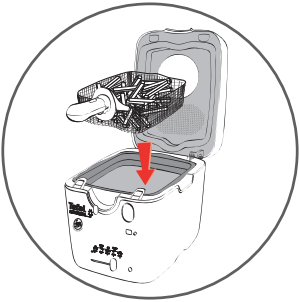
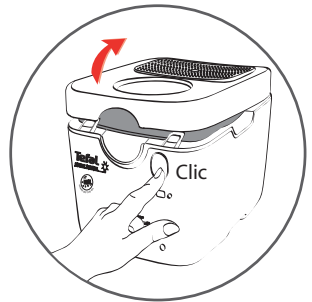
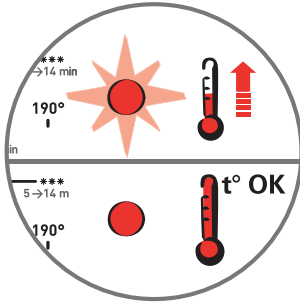
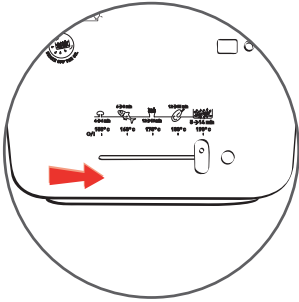
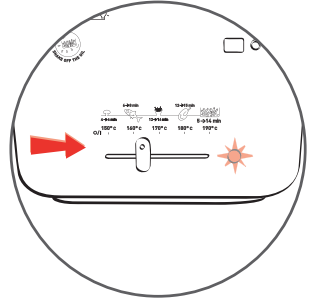
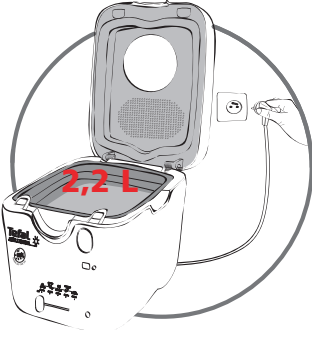
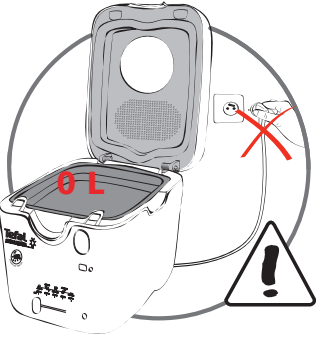



















Max.	1 kg
	500 g





5



7	Nb			
		1400 g	190°C	+/- 18 - 20 min.
		1400 g	① 160°C ② 190°C	+/- 11 - 14 min. +/- 7 - 9 min.
		700 g	170°C	+/- 11 - 15 min.
	8 - 10		190°C	+/- 9 - 10 min.
	3/4		180°C	+/- 14 - 16 min.
	1 - 2		170°C	+/- 6 - 8 min.
	6		170°C	+/- 3 - 4 min.
		200 g	150 °C	+/- 5 - 7 min.
	10 - 12		180°C	+/- 11 - 13 min.
	4		180°C	+/- 5 - 6 min.
* * *	Nb			
		1000 g	190°C	+/- 11 - 15 min.
		500 g	170°C	+/- 7 - 10 min.
	8 p		190°C	+/- 5 - 7 min.
	3/4 p		190°C	+/- 14 - 15 min.
		1500 g	190°C	+/- 12 - 16 min.
	12	180 g	190°C	+/- 3 - 4 min.

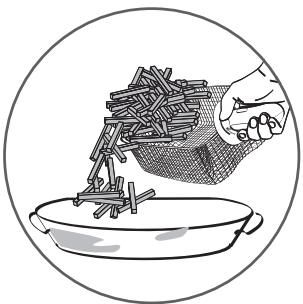
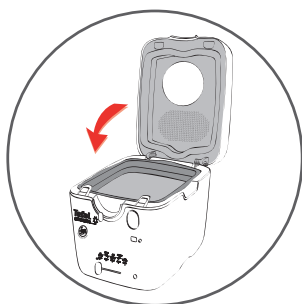
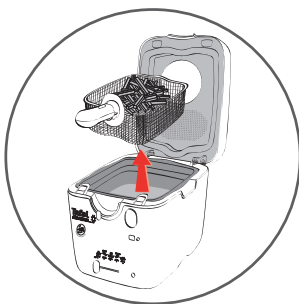
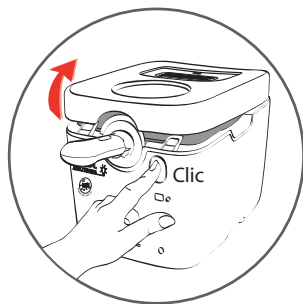
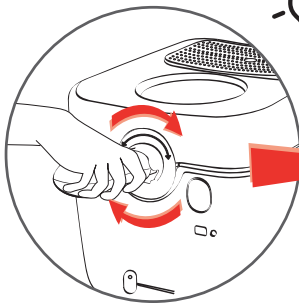
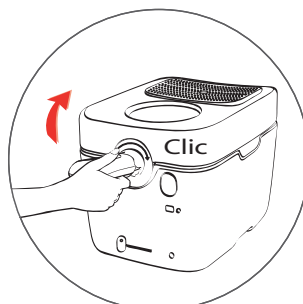
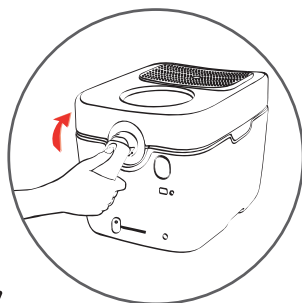
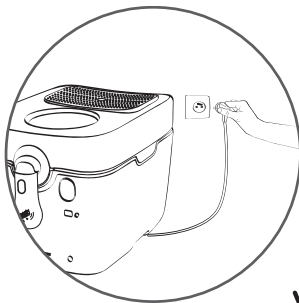
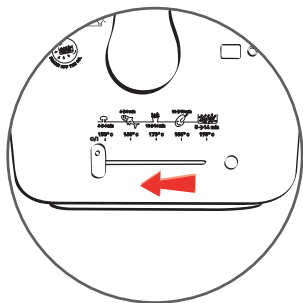

SIMPLY INVENTS



*

Shake off the oil, Secouage des frites, стряхивать излишки масла, Îndepărtați uleiul OTRESTI ULJE, otresa višak ulja, ISTRESTI ULJE, protrese te ulje, Изцеждане на мазнината, otresa višak ulja, ISTRESTI ULJE, protrese te ulje, Изцеждане на мазнината, لیتھما (لیتھما)؟ potrząsnać koszykiem w celu usunięcia nadmiaru oleju, "zliv olíi", Sacudir el aceite, ryster overskydende olie af, روغن را بچکانید, rist av oljen

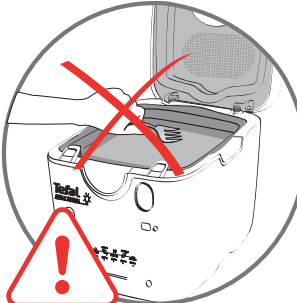
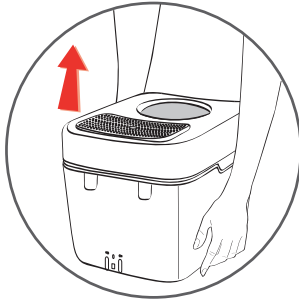
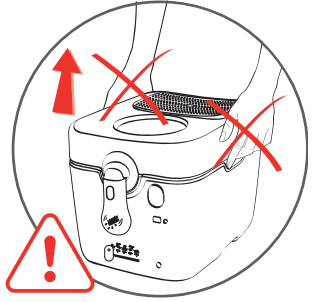

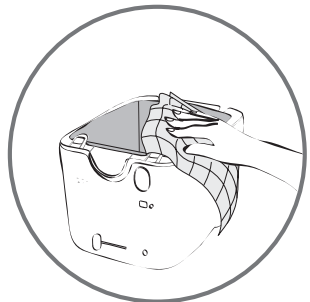
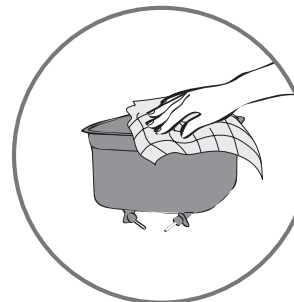
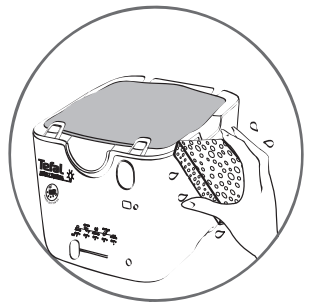
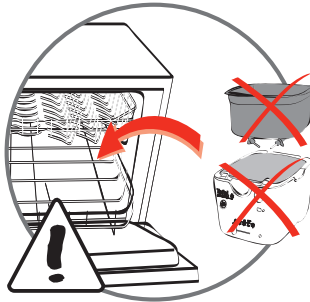
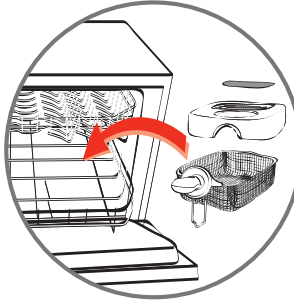
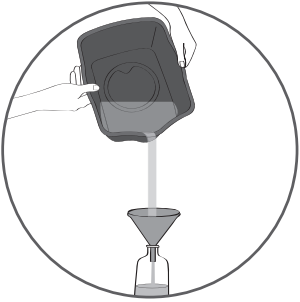
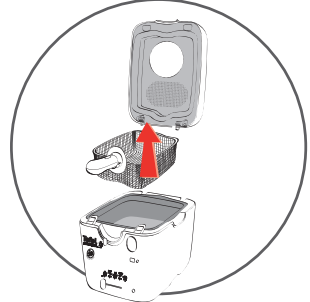
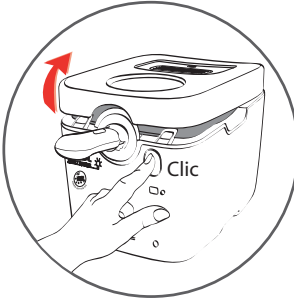
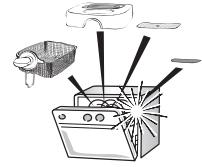

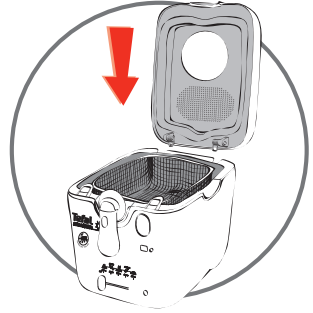
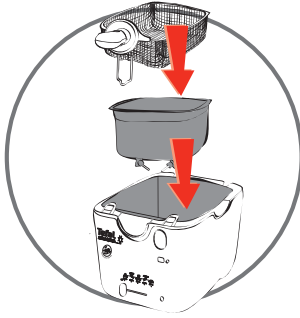
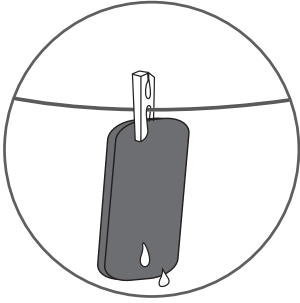

8

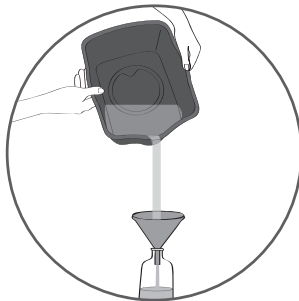

9

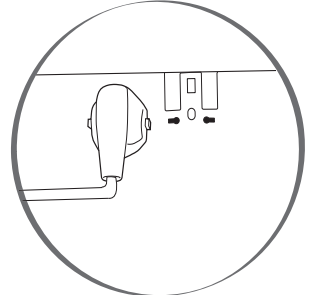
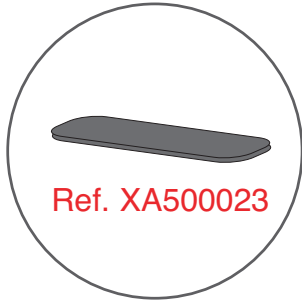
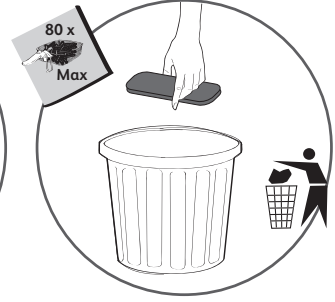

9

